

技术参数:

- 材料: 压铸铝
- 表面处理: 粉末喷涂
- 颜色: RAL 7037 (灰色)
- 温度范围:  $-40^{\circ}\text{C} - +125^{\circ}\text{C}$
- 防护等级: IP65
- 出线方向: 侧出线
- 出线孔数: 1
- 螺纹规格: M25
- 联锁元件:
  - 锁扣方式: 金属单扣
  - 材料: 不锈钢+软胶

Technical specification:

- Material: aluminium die-cast
- Surface: powder-coated
- Colour: RAL 7037(grey)
- Temperature range:  $-40^{\circ}\text{C} - +125^{\circ}\text{C}$
- Degree of protection: IP65
- Cable entry: side entry
- No. of cable entries: 1
- Thread size: M25
- Locking element:
  - Locking type: single locking latch
  - material: stainless steel+TPR

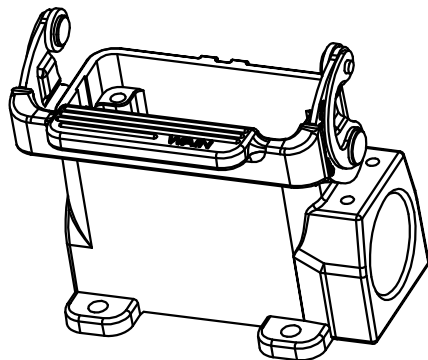

						表面处理 Finish	-			图号 Drawing No.	-
						材料 Material	-			产品代号 Part Code	H10A-SF-1L/SC-M25
标记 Mark	处数 Number	变更描述/Description		姓名 Signature	日期 Date					产品料号 Part No.	1100102211003
	姓名/Name	日期/Date		姓名/Name	日期/Date	比例 Scale	版本 REV.	重量 Weight	数量 Qty.	产品名称 Part Name	-
绘图 Drawn	SL CHEN	18.10.2010	标准化 Stand.	-	-	2:3	V1.0	162g	-		
审核 Checked	P RAO	18.10.2010									
工艺 Process	-	-	批准 Approved	YY LIN	18.10.2010			All Dimensions in mm Original Size DIN A 4		厦门唯恩电气有限公司 XIAMEN WAIN ELECTRICAL CO.LTD	